

Head-pieces HELUZ 14,5 - 200



Use

For the building opening lintel in non-load bearing walls.

Specifications

Manufacturing plant	JISTROP
Dimensions L x W x H (mm)	2000 x 145 x 71
Average weight inf.	43,26
Number of pieces per pallet	30
Pallet	Wooden block
Dispatch pallet weight avg. inf.	1352
Loading onto a truck (bm)	1350
Thermal conductivity lu (W / mK)	0,24
Reaction to fire class	Euroclass A1
Fire resistance (EN 1996-1-2)	R 90 D1 with plaster 20 mm

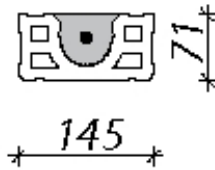
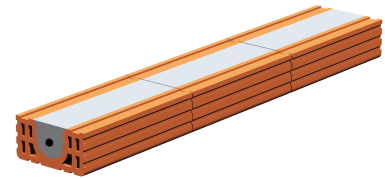

Coupled bearing lintel

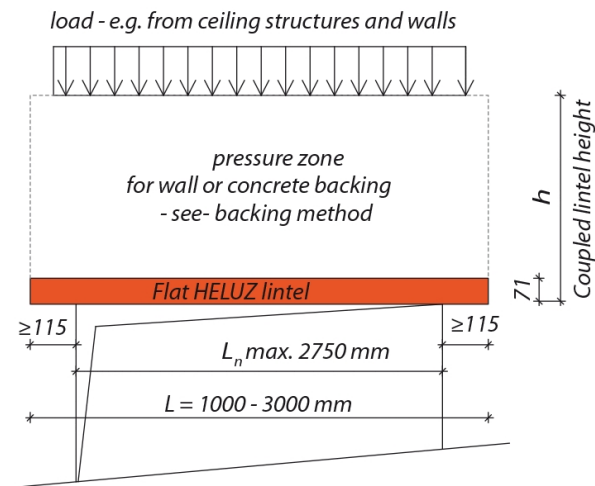

Non-bearing coupled lintels - limiting conditions

